

Lamellenvorhang L1 / DL1 Monomatik
Store à lamelles L1 / DL1 Monomatique

B
Optional
Verdeckter Clip
Options
Clip invisible

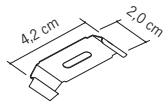

A
Sichtbarer Clip
Clip visible

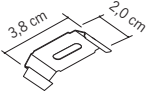
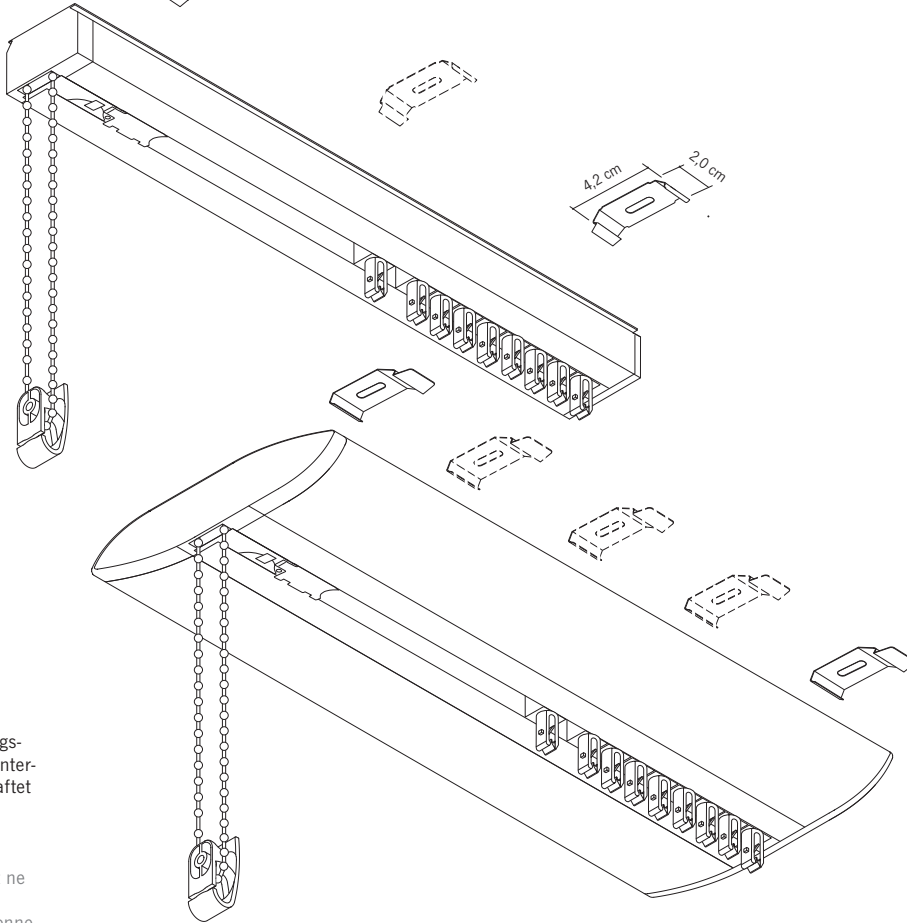

Achtung Attention:

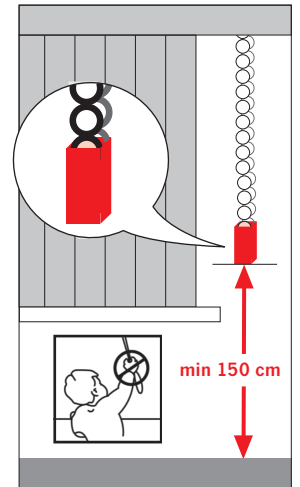

Montagezubehör

Das beiliegende Befestigungsmaterial gilt nur für feste Untergründe. Für die Montage haftet der Montierende.

Accessoires de montage

Le matériel de fixation joint ne peut être appliqué que sur des bases solides. La personne chargée du montage est responsable du montage.

Montagepunkte bestimmen

Déterminer les points de montage

A Sichtbarer Clip
Clip visible



3x-6x



3x-6x



3x-6x

Deckenmontage

Montage au plafond

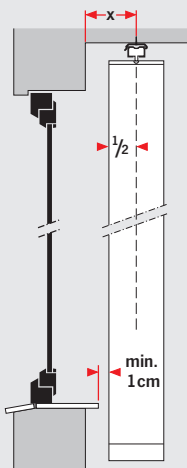

Wandmontage

Montage au mural

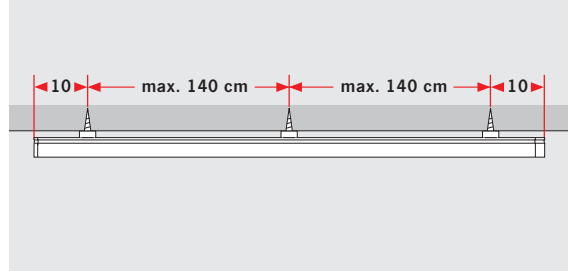
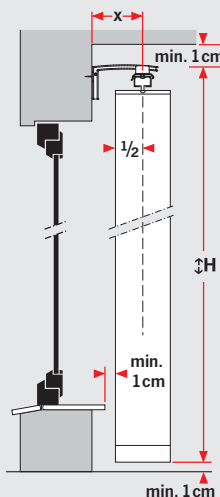

B Optional Verdeckter Clip
Options
Clip invisible

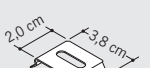

3x-6x



3x-6x



3x-6x

Montage

Montage

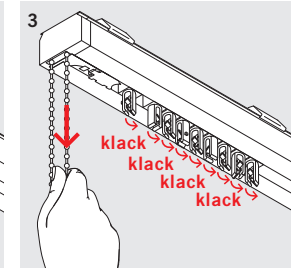
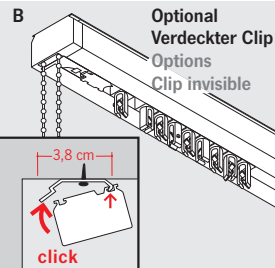
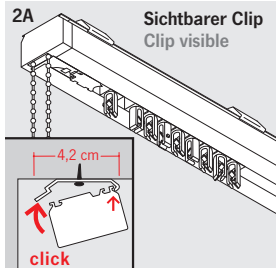
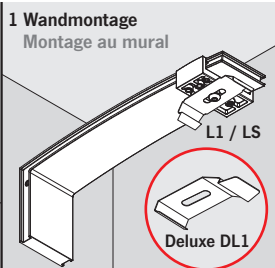
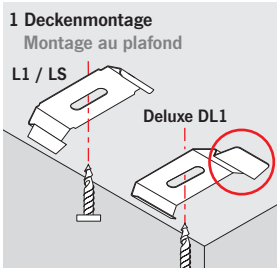

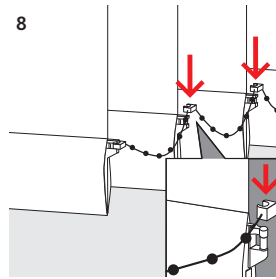
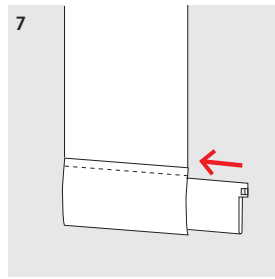
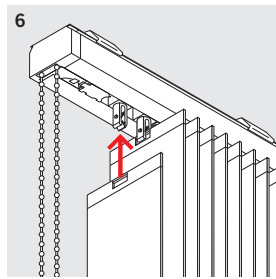
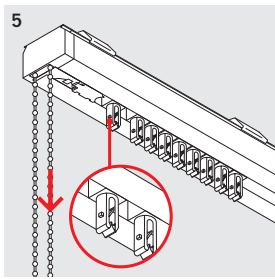
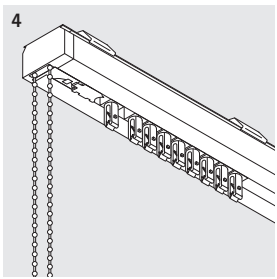

Bedienung:
Utilisation:

Schließen
Fermer

Wenden
Tourner

Gegenwenden
Tourner en sens inverse

Öffnen
Ouvrir

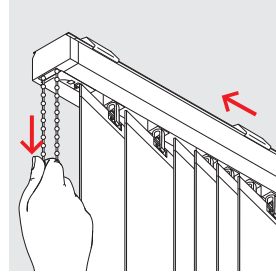
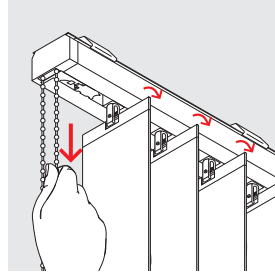
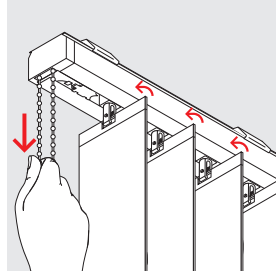
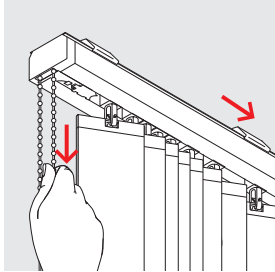

Paket verschieben
Déplacer le paquet

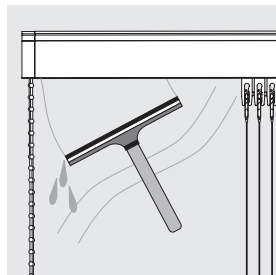
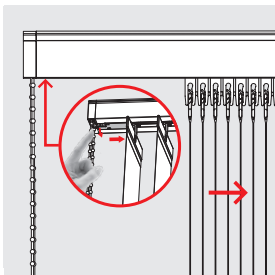

Demontage
Démontage

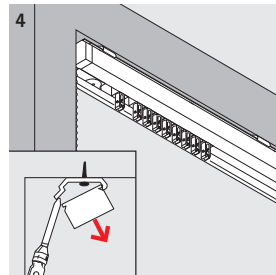
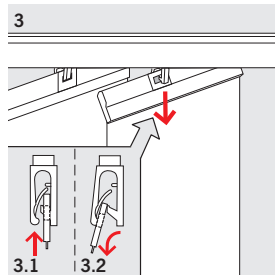
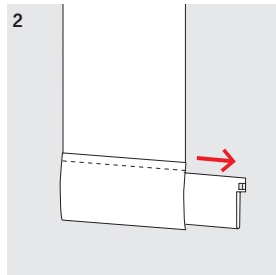
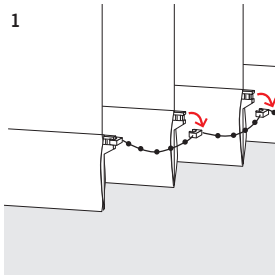

Auswechselbare Haken
(mit Spezialzange)
Achtung!
Schnecke gegen herausfallen
mit Kleband sichern.
Crochets interchangeables
(avec pince spéciale)
Attention!
Bloquer la roue dentée avec
du ruban adhésif pour éviter
qu'elle ne tombe sur le sol.

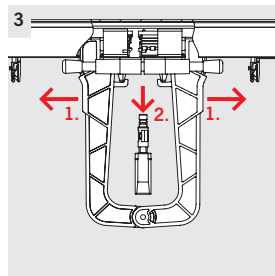
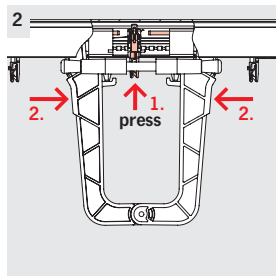
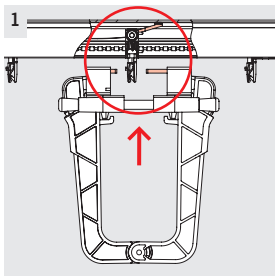

Erkeranlagen Montage:
Installations à encorbellement
Montage:

